

ANCHOR DIMENSION TABLE

A=	B=	C=	D=	E=	F=	G=	H=	I=	J=	K=

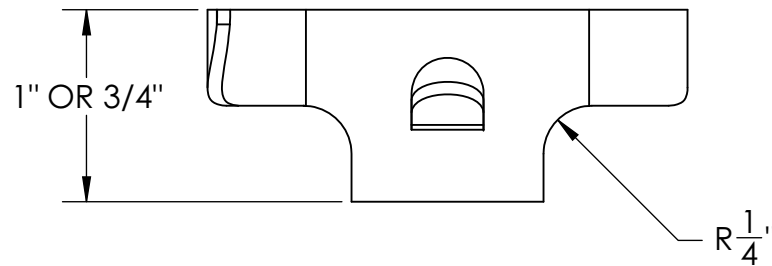
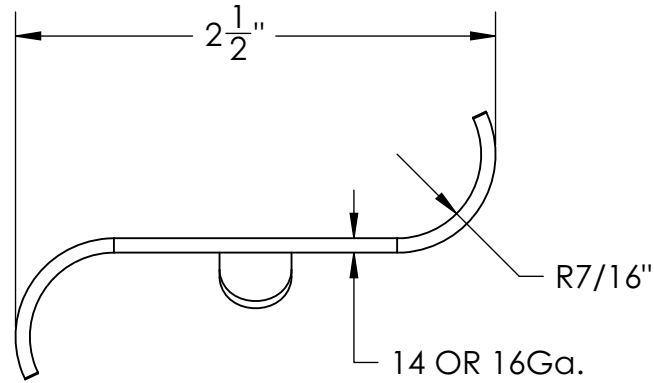

TFL-127